

# PRODUCT GUIDE 2016-17

Chimney Covers  
and Animal Prevention . . . . . 4

Outdoor Living . . . . . 20

Hearth Accessories . . . . . 24

Rotary Cleaning Systems . . . . 30

Chimney Inspection Cameras 33

Chimney Systems and Liners. 34

Wood and Coal Furnaces. . . . . 35



HOME SOLUTIONS BUILT BETTER



HOME SOLUTIONS BUILT BETTER

# Improving Your Life and the Life of Your Home

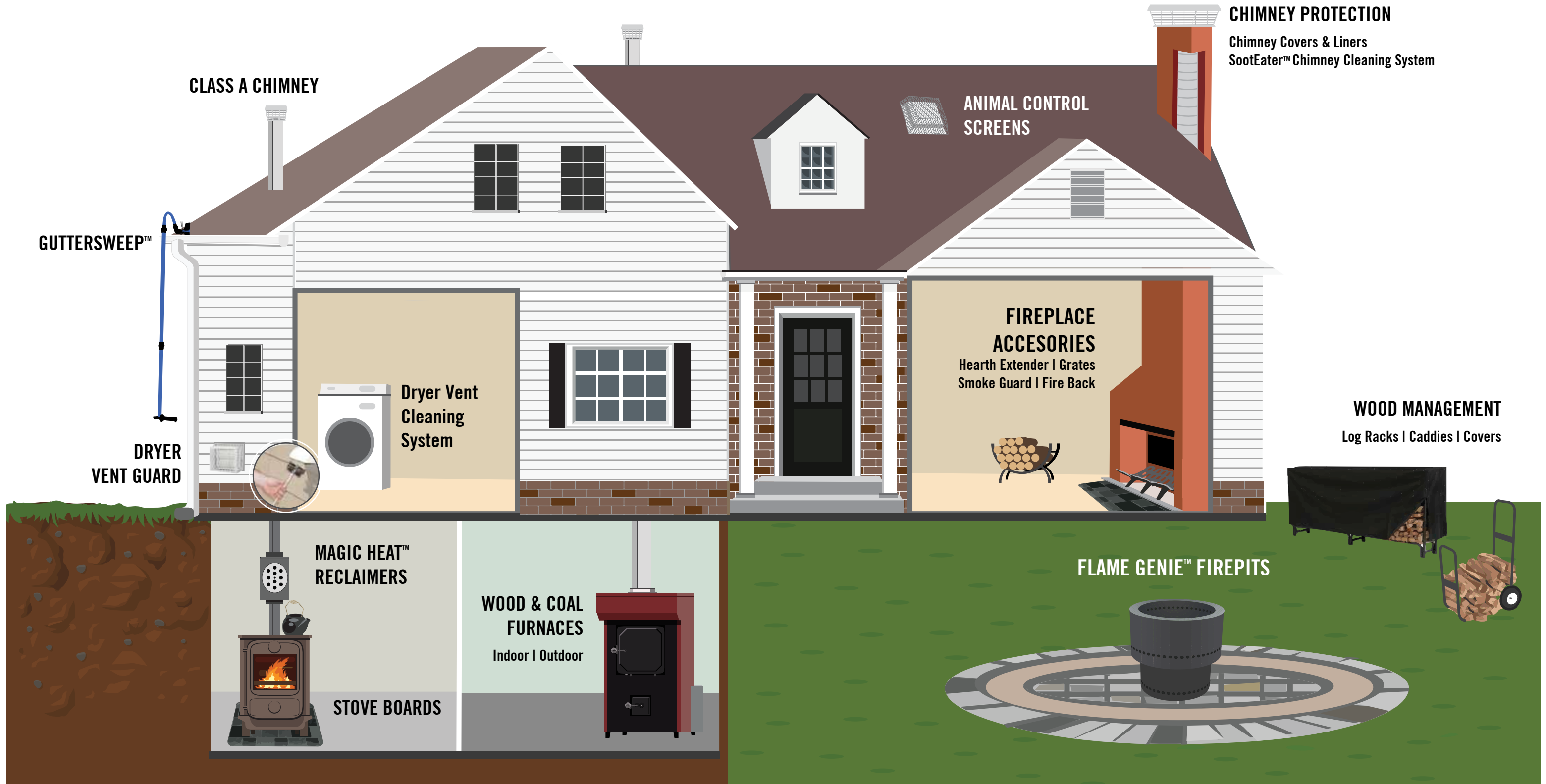

## Why HY-C?

HY-C people are passionate and committed to high performance. We are here to provide safety, security and sustainable living products to *improve your life and the life of your home.*

HY-C has been protecting homes and families since 1947 with home improvement products including chimney covers, stove boards, firewood management solutions, nuisance wildlife control screens, and cast iron fireplace accessories. Recent additions to the lineup include the LintEater and SootEater dryer vent and chimney cleaning products. The Magic Heat heat reclaimer and Flame Genie pellet fire pit also have recently joined the HY-C family.

Because we manufacture almost all of our products here in the United States, our customers are not waiting for containers that are 'on the water.' We provide what you need when you need it.

Customer Service, answered in St. Louis, Missouri:  
**1-800-325-7076**

## Chimney Covers | Draft King™ Single Flue



Copper

### FEATURES

- HY-C Lifetime Limited Warranty
- 24 Gauge 100% Copper Hood with Scalloped Corners and Roll-Formed Edges
- 18 Gauge 3/4" Expanded 100% Copper Mesh
- Removable Hood for Easy Chimney Cleaning
- 16 Gauge Copper Plated Stainless Steel Base for Extra Strength
- Slotted Hex-Head Stainless Steel Mounting Bolts
- Outside Mounting Provides Greater Free Air Space for Better Draft
- Expanded Metal Mesh Turned Inward at Base Allows Cover to Rest Firmly on Tile, Closing any Gaps around the Tile

STOCK NUMBER	OUTSIDE TILE SIZE (IN INCHES)	FITS OUTSIDE TILE DIMENSION (IN INCHES)	APPROX. LBS.
CP99	9 x 9	7½ x 7½ to 9½ x 9½	7
CP913	9 x 13	7½ x 11½ to 9½ x 13½	8.5
CP918	9 x 18	7½ x 16 ½ to 9¼ x 18¼	10
CP1216	12 x 16	10 x 14 to 12¼ x 16¼	11.5
CP1313	13 x 13	11½ x 11½ to 13½ x 13½	10
CP1318	13 x 18	11½ x 16½ to 13¼ x 18¼	12
CP1818	18 x 18	16½ x 16½ to 18 x 18	14.5

## Chimney Covers | Draft King™ Single Flue



Stainless Steel

### FEATURES

- HY-C Lifetime Limited Warranty
- 100% 304 Stainless Steel
- 24 Gauge Stainless Steel Hood with Scalloped Corners and Roll-Formed Edges
- 16 Gauge Stainless Steel Base for Extra Strength
- 18 Gauge 3/4" Expanded Stainless Steel Mesh
- 18 Gauge 5/8" Expanded Stainless Steel Mesh Available for California
- Slotted Hex-Head Stainless Steel Mounting Bolts
- Outside Mounting Provides Greater Free Air Space for Better Draft
- Expanded Metal Mesh Turned Inward at Base Allows Cover to Rest Firmly on Tile, Closing any Gaps around the Tile
- Optional Heavy-Duty Stainless Steel Leg Kit for Chimneys Where the Tile Does not Extend above the Crown
- Change "U" to "P" for Painted

STOCK NUMBER	OUTSIDE TILE SIZE (IN INCHES)	FITS OUTSIDE TILE DIMENSION (IN INCHES)	APPROX. LBS.
SS99U	9 x 9	7½ x 7½ to 9½ x 9½	6.5
SS913U	9 x 13	7½ x 11½ to 9½ x 13½	8
SS1313U	13 x 13	11½ x 11½ to 13½ x 13½	9.5
SS1318U	13 x 18	11½ x 16½ to 13¼ x 18¼	11
SS1818U	18 x 18	16½ x 16½ to 18 x 18	13
SS918U	9 x 18	7½ x 16½ to 9¼ x 18¼	9
SS59U	5 x 9	3½ x 7½ to 5½ x 9½	5
SS1216U	12 x 16	10 x 14 to 12½ x 16¼	10.5
SS1111U	11 x 11	9¾ x 9¾ to 12 x 12	9
SS1515U	15 x 15	13¾ x 13¾ to 16 x 16	11.5
SS2020U	20 x 20	18½ x 18½ to 20¼ x 20¼	14
SS811U	10 Round - Slip-In	9½ to 10½ Round	7.5
SS813U	12 Round - Slip-In	11½ to 12½ Round	9.5
SS815U	14 Round - Slip-In	13½ to 14½ Round	10
SS816U	16 Round - Slip-In	15½ to 16½ Round	10.5
SS818U	18 Round - Slip-In	17½ to 18½ Round	11
SS10U	10 Round - Bolt-On	9½ to 10½ Round	6
SS12U	12 Round - Bolt-On	11½ to 12½ Round	8
SS14U	14 Round - Bolt-On	13½ to 14½ Round	9
SS16U	16 Round - Bolt-On	15½ to 16½ Round	12
SS18U	18 Round - Bolt-On	17½ to 18½ Round	13
SSLK	Leg Kit	Option to Convert Draft King Into Slip-In	1.5
SSLK-M	Leg Kit (Packed 25)	Option to Convert Draft King Into Slip-In	38



SSLK - Leg Kit



Black Galvanized

STOCK NUMBER	OUTSIDE TILE SIZE (IN INCHES)	FITS OUTSIDE TILE DIMENSION (IN INCHES)	APPROX. LBS.
CBO99	9 x 9	7½ x 7½ to 9½ x 9½	7
CBO913	9 x 13	7½ x 11½ to 9½ x 13½	8
CBO1313	13 x 13	11½ x 11½ to 13½ x 13½	10
CBO1318	13 x 18	11½ x 16½ to 13¼ x 18¼	12
CBO1818	18 x 18	16½ x 16½ to 18 x 18	14.5
CBO918	9 x 18	7½ x 16½ to 9¼ x 18¼	10
CBO59	5 x 9	3½ x 7½ to 5½ x 9½	5.5
CBO1216	12 x 16	10 x 14 to 12½ x 16¼	11.5
CBO1111	11 x 11	9¾ x 9¾ to 12 x 12	9.5
CBO1515	15 x 15	13¾ x 13¾ to 16 x 16	13.5
CBO2020	20 x 20	18½ x 18½ to 20¼ x 20¼	15
CBO811	10 Round - Slip-In	9½ to 10½ Round	8
CBO813	12 Round - Slip-In	11½ to 12½ Round	10.5
CBO815	14 Round - Slip-In	13½ to 14½ Round	11
CBO816	16 Round - Slip-In	15½ to 16½ Round	11.5
CBO818	18 Round - Slip-In	17½ to 18½ Round	12
CBO8	8 Round - Bolt-On	7½ to 8½ Round	5.5
CBO10	10 Round - Bolt-On	9½ to 10½ Round	6
CBO12	12 Round - Bolt-On	11½ to 12½ Round	9
CBO14	14 Round - Bolt-On	13½ to 14½ Round	9.5
CBO16	16 Round - Bolt-On	15½ to 16½ Round	13
CBO18	18 Round - Bolt-On	17½ to 18½ Round	13.5
SSLK	Leg Kit	Option to Convert Draft King Into Slip-In	1.5
SSLK-M	Leg Kit (Packed 25)	Option to Convert Draft King Into Slip-In	38

### FEATURES

- Seven-Year Limited Warranty
- 24 Gauge Galvanized Steel Hood with Scalloped Corners and Roll-Formed Edges
- 14 Gauge Galvanized Steel Base for Extra Strength
- 18 Gauge 3/4" Expanded Galvanized Steel Mesh
- 18 Gauge 5/8" Expanded Galvanized Steel Mesh Available for California
- Attractive Black Powder Coat Finish
- Slotted Hex-Head Mounting Bolts
- Outside Mounting Provides Greater Free Air Space for Better Draft
- Expanded Metal Mesh Turned Inward at Base Allows Cover to Rest Firmly on Tile, Closing any Openings around Tile
- Optional Heavy-Duty Leg Kit for Chimneys Where the Tile Does not Extend above the Crown

**Note:** In situations where Oil or Coal is burned, or when Wood or Pellets are used as the primary source of heat, do not use Aluminum or Black-Painted Galvanized Steel Covers.

The stock numbers below are made with 5/8" expanded metal mesh and are used for flue tiles commonly found in California



California Style 5/8" Mesh

STOCK NUMBER STAINLESS	STOCK NUMBER BLK GALV.	OUTSIDE TILE SIZE (IN INCHES)	FITS OUTSIDE TILE DIMENSION (IN INCHES)	APPROX. LBS. STAINLESS	APPROX. LBS. BLK GALV.
SSC59U	CBC59	5 x 9	3½ x 7½ to 5½ x 9½	6.5	7
SSC820U	CBC820	8 x 20 Oval	6½ x 17 to 8½ x 19	10	10.5
SSC817U	CBC817	8 x 17 Oval 9 x 18 Rect.	7½ x 16½ to 9¼ x 18¼	9	10
SSC99U	CBC99	9 x 9	7½ x 7½ to 9½ x 9½	6.5	7
SSC913U	CBC913	9 x 13	7½ x 11½ to 9½ x 13½	8	8
SSC921U	CBC921	9 x 21 Oval	7½ x 19½ to 9½ x 21½	10.5	11
SSC1017U	CBC1017	10 x 17 Oval	9½ x 16½ to 11 x 18½	10.5	11.5
SSC1111U	CBC1111	11 x 11	9¾ x 9¾ to 12 x 12	9.5	10
SSC1216U	CBC1216	12 x 16	10 x 14 to 12½ x 16¼	11	12
SSC1313U	CBC1313	13 x 13	11½ x 11½ to 13½ x 13½	9.5	10
SSC1317U	CBC1317	13 x 17 Oval 13 x 17 Rect.	11½ x 16½ to 13¼ x 18½	11	12
SSC1321U	CBC1321	13 x 21 Oval	12 x 20 to 13½ x 22	13.5	14
SSC1515U	CBC1515	15 x 15	13¾ x 13¾ to 16 x 16	12	14
SSC1721U	CBC1721	17 x 21 Oval	16 x 20 to 17½ x 22	15	15.5
SSC1818U	CBC1818	18 x 18	16½ x 16½ to 18 x 18	13.5	14.5
SSC2020U	CBC2020	20 x 10	18½ x 18½ to 20¼ x 20¼	14.5	15.5
SSC811U	CBC811	10 Round - Slip-In	9½ to 10½ Round	8	8.5
SSC813U	CBC813	12 Round - Slip-In	11½ to 12½ Round	10	11
SSC815U	CBC815	14 Round - Slip-In	13½ to 14½ Round	10.5	11.5
SSC816U	CBC816	16 Round - Slip-In	15½ to 16½ Round	11	12
SSC818U	CBC818	18 Round - Slip-In	17½ to 18½ Round	11.5	12.5
SSC8U	CBC8	8 Round - Bolt-On	7½ to 8½ Round	5.5	6
SSC10U	CBC10	10 Round - Bolt-On	9½ to 10½ Round	6	6.5
SSC12U	CBC12	12 Round - Bolt-On	11½ to 12½ Round	8.5	9.5
SSC14U	CBC14	14 Round - Bolt-On	13½ to 14½ Round	9.5	10.5
SSC16U	CBC16	16 Round - Bolt-On	15½ to 16½ Round	12.5	13.5
SSC18U	CBC18	18 Round - Bolt-On	17½ to 18½ Round	13.3	14

# Chimney Covers | BigTop™ Multi-Flue

## FEATURES - COPPER

- HY-C Lifetime Limited Warranty
- 24 Gauge Removable 100% Copper Hood with Scalloped Corners and Roll-Formed Edges
- 24 Gauge Copper-Plated Stainless Steel Base Flanges for Extra Strength in Mounting
- 18 Gauge 3/4" 100% Copper Expanded Metal Mesh, Available in 9", 12" & 14" Heights
- Also Available with Hinged Mounting Flanges
- Available in Many Stock and Custom Sizes



## FEATURES - STAINLESS

- HY-C Lifetime Limited Warranty
- 24 Gauge Removable 100% 304 Stainless Steel Hood with Scalloped Corners and Roll-Formed Edges
- 24 Gauge 100% 304 Stainless Steel Base Flanges for Secure Mounting
- 18 Gauge 3/4" 100% 304 Stainless Steel Expanded Metal Mesh, Available in 8", 10" & 14" Heights
- 18 Gauge 5/8" 100% 304 Stainless Steel Expanded Metal Mesh, Avail. in 8", 10" & 14" Heights for California
- Also Available with Hinged Mounting Flanges
- Available in Many Stock and Custom Sizes



## FEATURES - BLACK GALVANIZED

- HY-C Seven-Year Limited Warranty
- 24 Gauge Removable Galvanized Steel Hood with Scalloped Corners and Roll-Formed Edges
- 24 Gauge Galvanized Steel Base Flanges for Secure Mounting
- Attractive Black Powder Coat Paint Finish
- 18 Gauge 3/4" Galvanized Steel Expanded Metal Mesh, Available in 8", 10" & 14" Heights
- 18 Gauge 5/8" Galvanized Steel Expanded Metal Mesh, Avail. in 8", 10" & 14" Heights for California
- Available in Many Stock and Custom Sizes

**Note:** In situations where Oil or Coal is burned, or when Wood or Pellets are used as the primary source of heat, do not use Aluminum or Black-Painted Galvanized Steel Covers.

**Note:** For Covers greater than 26" in width and/or 54" in length (screen to screen size), the lid resembles that of the Band-Around Cover - see page 10.

**To install:** Use a 3/16" Masonry Bit.

# Chimney Covers | BigTop™ Multi-Flue

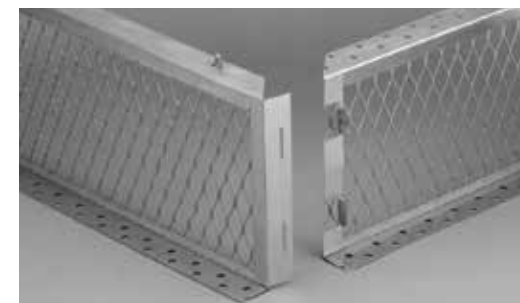

Easy to assemble with tab and slot corner design. Hood attaches to base with weld bolts and nuts; no chance of stripping out threaded holes. Hinged mounting flanges available on Stainless Steel and Copper models.

## HY-C Big Top™ - Easy Solution for the Multi-Flue Chimney

The Knocked-Down (KD) design is very easy to assemble on the job site, eliminating cumbersome storage of large assembled units.

STOCK NUMBER COPPER	STOCK NUMBER STAINLESS	STOCK NUMBER STAINLESS HINGED	STOCK NUMBER BLACK GALVANIZED	SCREEN-TO- SCREEN (IN INCHES)	HOOD SIZE (IN INCHES)	APPROX. LBS.
CBT1010	BT1010	BTH1010	BBT1010	10 x 10	16 x 16	8.5
CBT1014	BT1014	BTH1014	BBT1014	10 x 14	15¼ x 19¼	9
CBT1319	BT1319	BTH1319	BBT1319	13 x 19	20¼ x 25¼	11.5
CBT1414	BT1414	BTH1414	BBT1414	14 x 14	20¼ x 20¼	10
CBT1717	BT1717	BTH1717	BBT1717	17 x 17	25¼ x 25¼	13
CBT1421KD	BT1421KD	BTH1421KD	BBT1421KD	14 x 21	22¼ x 34½	15.5
CBT1426KD	BT1426KD	BTH1426KD	BBT1426KD	14 x 26	22¼ x 34½	16
CBT1430KD	BT1430KD	BTH1430KD	BBT1430KD	14 x 30	22¼ x 34½	16.5
CBT1434KD	BT1434KD	BTH1434KD	BBT1434KD	14 x 34	22¼ x 46½	19.5
CBT1537KD	BT1537KD	BTH1537KD	BBT1537KD	15 x 37	22¼ x 46½	20
CBT1729KD	BT1729KD	BTH1729KD	BBT1729KD	17 x 29	22¼ x 34½	16.5
CBT1735KD	BT1735KD	BTH1735KD	BBT1735KD	17 x 35	22¼ x 46½	19
CBT1741KD	BT1741KD	BTH1741KD	BBT1741KD	17 x 41	22¼ x 46½	21
CBT1749KD	BT1749KD	BTH1749KD	BBT1749KD	17 x 49	22¼ x 58¼	22
CBT1753KD	BT1753KD	BTH1753KD	BBT1753KD	17 x 53	22¼ x 58¼	23
CBT1758KD	BT1758KD	BTH1758KD	BBT1758KD	17 x 58	22¼ x 69¼	27
CBT1764KD	BT1764KD	BTH1764KD	BBT1764KD	17 x 64	22¼ x 69¼	29

Shipped assembled only

Stock sizes and custom sizes shipped knocked-down to minimize freight expense and to avoid shipping damage. Tube of all-weather construction adhesive cannot be shipped air freight.

### CUSTOM-MADE Big Top™

Available with the following limitations:

COVER TYPE	MAX WIDTH	MAX LENGTH
Copper	40"	88"
Stainless	40"	88"
Black	40"	96"

All units ≥ 32" width, will be shipped with a minimum of 10" mesh

## FEATURES

- HY-C Lifetime Limited Warranty for Copper and Stainless Steel, 7-year Limited Warranty on Black Galvanized Steel
- Heavy-Duty Welded Construction
- 24 Gauge Removable Hood for Easy Cleaning
- Scalloped Corners and Roll-Formed Edges Add Style and Safety
- Knocked Down Big Tops are Assembled at the Factory Before Shipping to Assure the Proper Fit of All Parts
- Tapmark Masonry Screws and Tube(s) of All-Weather Construction Adhesive Included

# Chimney Covers | Multi-Pack Single Flue



## FEATURES

- 100% 304 Stainless Steel
- HY-C Lifetime Limited Warranty
- Space Saving Design and Package
- Easy Assembly, Lids Attach in Seconds with Wing Nuts (included) and Weld Bolts to Prevent Stripping
- Removable 24 Gauge Hood with Roll-Formed Edges
- Ships Nested in a 4-pack Carton
- 16 Gauge Stainless Steel Base for Extra Strength
- 18 Gauge 3/4" Expanded Stainless Steel Mesh
- Side Bolt-on Mounting with Pointed Stainless Steel Slotted Hex-head Bolts with Weld Nuts to Prevent Stripping

STOCK NUMBER	OUTSIDE TILE SIZE (IN INCHES)	FITS OUTSIDE TILE DIMENSION (IN INCHES)	CARTON PACK	APPROX. LBS
MPSS99	9 x 9	7½ x 7½ to 9½ x 9½	4	22
MPSS913	9 x 13	7½ x 11½ to 9½ x 13½	4	27
MPSS918	9 x 18	7½ x 16½ to 9½ x 18¼	4	34
MPSS1212	12 x 12	10½ x 10½ to 12½ x 12½	4	33
MPSS1313	13 x 13	10½ x 11½ to 13½ x 13½	4	34
MPSS1318	13 x 18	11½ x 16½ to 13¼ x 18¼	4	45

# Chimney Covers | Liner Cap Single Flue

STOCK NUMBER	OUTSIDE TILE SIZE (IN INCHES)	FITS OUTSIDE TILE DIMENSION (IN INCHES)	APPROX. LBS.
LC4	4	3½ to 4½	4
LC5	5	4½ to 5½	4
LC6	6	5½ to 6½	4.3
LC7	7	6½ to 7½	4.3
LC8	8	7½ to 8½	5
LC9	9	8½ to 9½	5
LC10	10	9½ to 10½	5.5
LC11	11	10½ to 11½	6
LC12	12	11½ to 12½	6
LC13	13	12½ to 13½	6.5
LC14	14	13½ to 14½	6.5

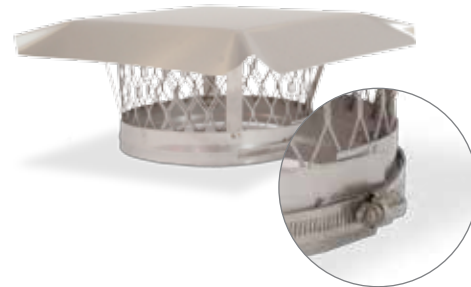

HY-C's liner cap is specifically designed to fit rigid and flexible stainless steel liners. It is also adaptable for use with clay flue liners and other round applications.

## FEATURES

- 100% 304 Stainless Steel
- HY-C Lifetime Limited Warranty
- Completely Assembled With Welded Construction
- Liner Cap Is Easily Mounted With 11/2" Draw Band
- Removable 18 Gauge 3/4" Expanded Stainless Steel Mesh
- Removable 18 Gauge 5/8" Expanded Stainless Steel Mesh Available for California
- Stainless Steel Gear-Drawn Clamp Band
- 24 Gauge Hood
- 24 Gauge Base; 18 Gauge Braces

Made in the U.S.A.

# Chimney Covers | Universal Covers

## NEW! Universal Covers

Now available from HY-C - Reliable and Easy-to-Install Universal Chimney Covers with Anchoring System

## FEATURES

- Available in 22-Gauge 304 Stainless Steel or 22-Gauge Galvanized Steel Powder Coated Black
- Lifetime Warranty on Stainless Steel, 7-year Limited Warranty on Galvanized
- Fits 95% of Chimneys in California
- Secure, Inside Anchoring System is Ideal for Windy Conditions



Black Galvanized, Standard 3/4" Mesh



Stainless Steel, Standard 3/4" Mesh



Black Galvanized, California 5/8" Mesh



Stainless Steel, California 5/8" Mesh



Damper Kit, available in both sizes

STOCK NO	DESCRIPTION	APPROX. LBS.
U1313B34	13 x 13 Black Galvanized	8.5
U1313S34	13 x 13 Stainless Steel	8
U1313B58	13 x 13 Black Galvanized, 5/8" Mesh	8.5
U1313S58	13 x 13 Stainless Steel, 5/8" Mesh	8
UD1313	13 x 13 Damper Kit	4
U1320B34	13 x 20.5 Black Galvanized	11
U1320S34	13 x 20.5 Stainless Steel	10
U1320B58	13 x 20.5 Black Galvanized, 5/8" Mesh	12.5
U1320S58	13 x 20.5 Stainless Steel, 5/8" Mesh	11
UD1320	13 x 20.5 Damper Kit	4

Made in the U.S.A.

# Chimney Covers | Custom Made Band-Around

## Aluminum and Stainless Steel

### ALUMINUM

Custom covers can be built to fit virtually any size chimney. Aluminum is recommended for most applications for low cost and minimal maintenance requirements.

Maximum base size: 60" wide x 96" long

### STAINLESS STEEL

Stainless Steel is recommended for use with coal or oil burning. Backed by the HY-C Lifetime Limited Warranty.

Maximum base size: 48" wide x 96" long



The hood overhangs masonry approximately 3" on both sides and ends. The cover attaches securely to the chimney with a 2¼" draw band. Four adjustable corner clamps provide ample flexibility for proper fit.

### How To Order:

1) Measure the outside dimension of all four sides of the top row of brick.

2) Measure the tile height from the top of the first row of brick, to the top of the tallest tile.

Any questions, call:  
**1-800-325-7076**

Example Top View

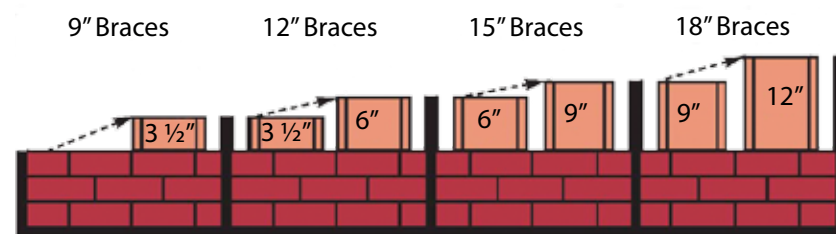
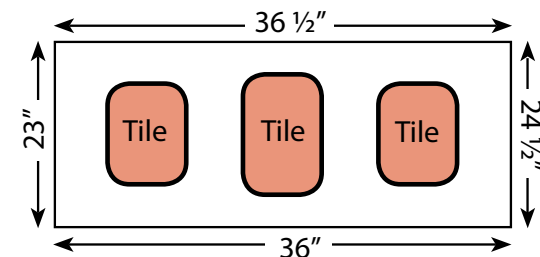

Standard 9" braces and expanded metal mesh are used when flue tile height is 3½" or less. If tile height is greater, refer to the chart.

All Custom covers are shipped knocked down. All units ≥ 32" width will be shipped with a minimum of 12" mesh.

**Note:** In situations where Oil or Coal is burned, or when Wood or Pellets are used as the primary source of heat, do not use Aluminum covers.

# Chimney Covers | Custom Made Skirt Type

## Aluminum, Stainless Steel and Copper

### ALUMINUM

Custom covers can be built to fit virtually any size chimney. Aluminum is recommended for most applications to supply low cost and minimal maintenance requirements.

Maximum base size: 60" wide x 96" long

### STAINLESS STEEL

Stainless Steel is recommended for use with coal or oil burning. Backed by the HY-C Lifetime Limited Warranty.

Maximum base size: 48" wide x 96" long

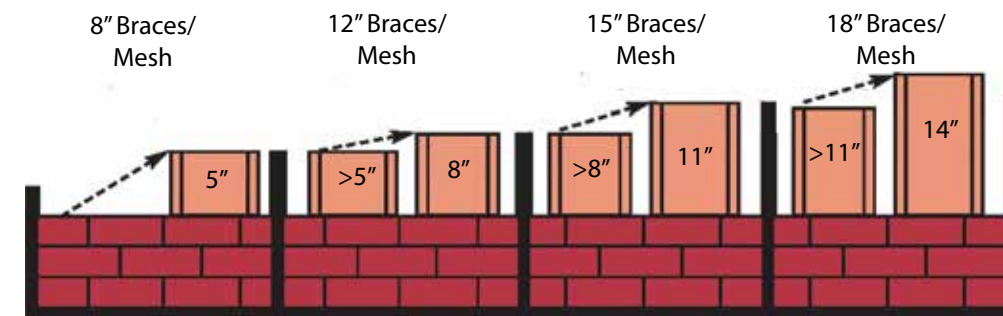

For Aluminum and Stainless Steel, standard 8" braces and expanded metal mesh are used when flue tile height is 6½" or less. If tile height is greater, refer to the chart.

### COPPER

Enhance the beauty of your home while protecting your chimney with a copper custom-made cover. Match your copper trim, gutters, or awnings.

Maximum base size: 38" wide x 88" long

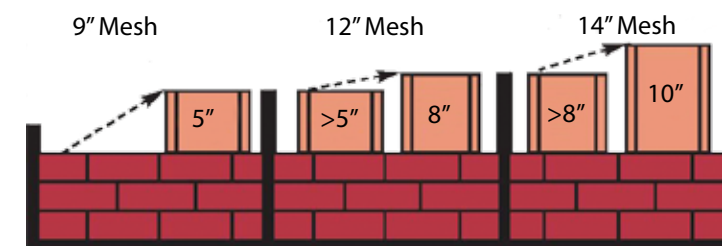

For Copper, standard 9" expanded metal mesh is used when flue tile height is 5" or less. If tile height is greater, refer to the chart.

The hood overhangs masonry approximately 1" on both sides and ends. 4¾" skirt protects cement crown from deterioration due to weather. Copper and Stainless Steel are constructed in the same manner.

Any questions, call:  
**1-800-325-7076**

# Chimney Covers | Adjustable Single Flue



Black Galvanized Adjustable

### FEATURES

- Seven-Year Limited Warranty
- One Cover Fits Several Flue Tile Sizes, Reducing SKUs
- Quick and Easy Installation
- Helps Protect Masonry Chimney from Deterioration
- Helps Protect Internal Metal Fireplace Fixtures
- Keeps out Rain, Birds, Animals and Debris
- Arrests Sparks and Reduces Certain Downdrafts
- 24 Gauge Galvanized Hood

STOCK NUMBER	FITS OUTSIDE TILE SIZE (IN INCHES)		APPROX. LBS
	APPROX. LBS		
SCADJ-S	8 x 8		8
	9 x 9		
	8 x 12		
	9 x 13		
	12 x 12		
	13 x 13		
	8 Round		
	10 Round		
12 Round			

STOCK NUMBER	FITS OUTSIDE TILE SIZE (IN INCHES)		APPROX. LBS
	APPROX. LBS		
SCADJ-L	13 x 13		10
	13 x 18		
	9 x 18		
	12 x 16		
	8 x 17 Oval		
	10 x 17 Oval		
13 x 17 Oval			

- 3/4" Expanded Galvanized Steel Mesh
- 5/8" Expanded Galvanized Steel Mesh Available for California (Stock #SCADJ-S-C & SCADJ-L-C)
- Attractive Black Powder Coat Finish

# Chimney Covers | Duro-Shield™ Single Flue

STOCK NUMBER	OUTSIDE BRICK SIZE (IN INCHES)	FITS OUTSIDE BRICK DIMENSION (IN INCHES)	APPROX. LBS.
188B	16 x 16	15½ x 15½ to 17½ x 17½	5.5
180B	17 x 17	16½ x 16½ to 18½ x 18½	5.7
182B	17 x 21	16½ x 20½ to 18½ x 22½	6.5
184B	21 x 21	20½ x 20½ to 22½ x 22½	7.5



Duro-Shield™ Aluminum Band-Around-Brick

Hood is made from 18 Gauge diamond embossed aluminum. Braces are 1/8" and 3/4" extruded aluminum. Mesh is 16 gauge aluminum expanded metal. Band is 2¼" - 18 gauge diamond embossed aluminum. Nuts and bolts are stainless steel. All covers shipped knocked down. Assembly required. Easy to install.

STOCK NUMBER	OUTSIDE TILE SIZE (IN INCHES)	FITS OUTSIDE TILE DIMENSION (IN INCHES)	APPROX. LBS.
MF303	9 x 9	7 x 7 to 9½ x 9½	4
	9 x 13	7 x 11½ to 9½ x 13½	
	13 x 13	11½ x 11½ to 13½ x 13½	
	10 Round	9 to 10 Round	
	12 Round	11½ to 12½ Round	
MF304	13 x 13	11½ x 11½ to 13½ x 13½	4.5
	13 x 18	11½ x 17 to 13½ x 18¼	
	9 x 18	7 x 17½ to 9½ x 18¼	
	12 x 16	11½ x 15 to 12½ x 16½	
	8 x 17 Oval	any near size	
	13 x 17 Oval	any near size	
MF305	10½ x 18 Oval	any near size	5
	18 x 18	17½ x 17½ to 18¼ x 18¼	
	14 Round	13 to 14½ Round	
	16 Round	16 to 17 Round	
	18 Round	17½ to 18¼ Round	



Duro-Shield™ Aluminum Multi-Fit

Hood is made from 18 Gauge diamond embossed aluminum. Braces are 1/8" and 1" extruded aluminum. Mesh is 16 gauge aluminum expanded metal. Nuts and bolts are stainless steel.

Made in the U.S.A.

# Chase Covers | Custom-Made



### FEATURES

- Available in 22-Gauge 304 Stainless Steel or 22-Gauge Galvanized Steel Powder Coated Black
- Custom Built to Ensure a Proper Fit
- Lifetime Warranty on Stainless Steel, 7-year Limited Warranty on Galvanized
- Cross Break to Shed Water and Provide Stability
- Corners are Welded for Superior Strength
- Protects Home from Water Damage
- Helps Maintain Safe Operation of Fireplace

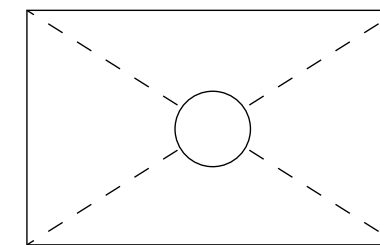

Top View

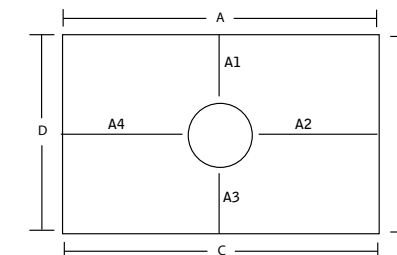

Single Hole

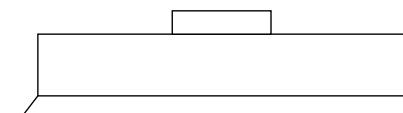

Side View

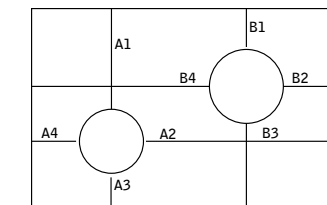

Double Hole

How to Measure for a Custom Chase Cover: (Give all dimensions to the nearest 1/8")

1. Measure the perimeter of the chimney, beginning with the longest side and going clockwise.
2. Measure the height of the skirt – 3" is standard.
3. Measure the diameter of the hole or each hole if there are more than one. Then measure the distance from the edge of each hole to each of the four sides.
4. 2" is the standard collar height. If a storm collar is needed, give outside diameter of each pipe.

Made in the U.S.A.

## Raccoon Screen

STOCK NUMBER	OUTSIDE TILE SIZE (IN INCHES)	FITS OUTSIDE TILE DIMENSION (IN INCHES)	APPROX. LBS.
RC99	9 x 9	7½ x 7½ to 9½ x 9½	4.7
RC913	9 x 13	7½ x 11½ to 9½ x 13½	5.5
RC1313	13 x 13	11½ x 11½ to 13½ x 13½	6.5
RS99	9 x 9	7½ x 7½ to 9½ x 9½	4.5
RS913	9 x 13	7½ x 11½ to 9½ x 13½	5
RS1313	13 x 13	11½ x 11½ to 13½ x 13½	6



RC = Black-Painted Steel RS = Stainless Steel

### FEATURES

- Galvanized Units are Painted Black, Stainless Steel Units are Unpainted
- The RC Units are Constructed with Heavy 18 Gauge Galvanized 5/8" mesh, the base is 14 Gauge Galvanized Steel
- With Tamper-Proof Bolt-on Attachment Method, Animal Pests are Unable to Remove the Screen to Gain Access to the Chimney Liner
- Standard Height is 6"
- The RS Units are 100% 304 Stainless Steel constructed with Heavy 18 Gauge 5/8" mesh, the base is a durable 16 Gauge Stainless Steel

## Spark Arrestor/ Bird and Squirrel Screen

STOCK NUMBER	FITS OUTSIDE TILE DIMENSION (IN INCHES)	APPROX. LBS.
2020	8 x 8 or 9 x 9*	3
2025	8 x 12 or 9 x 13*	3
2525	12 x 12 or 13 x 13*	3.5
1010	10 Round	2.5
1212	12 Round	3
1414	14 Round	3.5



NO TOOLS NEEDED! The Screens are easy to install, simply slip the heavy corner fins down into the flue tile.

\*Fits either size

### FEATURES

- Heavy 16 Gauge 5/8" Galvanized Steel Mesh
- The Entire Unit is Made from Galvanized Steel and Painted Black to Resist Oxidation
- Effective Barrier to Small Animal Pests Such as Birds and Squirrels - Keeps them out of the Chimney

## Dryer VentGuard

STOCK NUMBER	SIZE (W x D x H) (IN INCHES)	CASE PACK	APPROX. LBS.
RVG-DVG	7 x 7 x 5	1	1
RVG-DVG-3	7 x 7 x 5	3	2
RVG-DVG-6	7 x 7 x 5	6	4



### FEATURES

- Easy to Install Over Most 3" or 4" Dryer or Bathroom Exhaust Vents
- Prevents Small Animals Such as Birds, Squirrels and Other Rodents from Nesting in Dryer Vents
- 100% 304 Stainless Steel Mesh that will Not Rust or Corrode
- The White Powder Coat Finish is Durable and Blends into Most Exterior Surfaces
- Should be Cleaned Out at Least Once per Month, Easy Keyhole On/Off

## Stainless Steel

STOCK NUMBER	SCREEN SIZE* (IN INCHES)	CASE PACK	APPROX. LBS.
RVG77	7 x 7 Base x 9 Height	1	1.5
RVG77-3	7 x 7 Base x 9 Height	3	5
RVG77P	7 x 7 Base x 9 Height	1	1.5
RVG77-3P	7 x 7 Base x 9 Height	3	5
RVG1111	11 x 11 Base x 13 Height	1	2.5
RVG1111-3	11 x 11 Base x 13 Height	3	9
RVG1111P	11 x 11 Base x 13 Height	1	2.5
RVG1111-3P	11 x 11 Base x 13 Height	3	9
RVG1616	16 x 16 Base x 5 Height	1	3.5
RVG1616-3	16 x 16 Base x 5 Height	3	10
RVG1616P	16 x 16 Base x 5 Height	1	3.5
RVG1616-3P	16 x 16 Base x 5 Height	3	10
RVG2525L	25 x 25 Base x 6 Height	1	7
RVG2525L-3	25 x 25 Base x 6 Height	3	21.5
RVG2525LP	25 x 25 Base x 6 Height	1	7
RVG2525L-3P	25 x 25 Base x 6 Height	3	21.5
RVG2525	25 x 25 Base x 12 Height	1	7.5
RVG2525-3	25 x 25 Base x 12 Height	3	22
RVG2525P	25 x 25 Base x 12 Height	1	7.5
RVG2525-3P	25 x 25 Base x 12 Height	3	22
RVG3030	30 x 30 Base x 12 Height	1	9
RVG3030-3	30 x 30 Base x 12 Height	3	26
RVG3030P	30 x 30 Base x 12 Height	1	9
RVG3030-3P	30 x 30 Base x 12 Height	3	26

P = Stainless Steel Painted Black

\* For Flange size, add 1.25" per side

## Black Painted Galvanized Steel

STOCK NUMBER	SCREEN SIZE* (IN INCHES)	CASE PACK	APPROX. LBS.
RVG77G	7 x 7 Base x 9 Height	1	1.5
RVG77-3G	7 x 7 Base x 9 Height	3	5
RVG1111G	11 x 11 Base x 13 Height	1	2.5
RVG1111-3G	11 x 11 Base x 13 Height	3	9
RVG1616G	16 x 16 Base x 5 Height	1	3.5
RVG1616-3G	16 x 16 Base x 5 Height	3	10
RVG2525LG	25 x 25 Base x 6 Height	1	7
RVG2525L-3G	25 x 25 Base x 6 Height	3	21.5
RVG2525G	25 x 25 Base x 12 Height	1	7.5
RVG2525-3G	25 x 25 Base x 12 Height	3	22
RVG3030G	30 x 30 Base x 12 Height	1	9
RVG3030-3G	30 x 30 Base x 12 Height	3	26

\* For Flange size, add 1.25" per side

### FEATURES

- Made from Heavy-Duty 18 Gauge expanded mesh in Stainless Steel or Galvanized
- Available in multiple sizes to fit a wide variety of vent applications

**KEEPS OUT RACCOONS, OPOSSUM, SQUIRRELS AND OTHER PESKY ANIMALS**

Roof VentGuard™ from HY-C prevents animals from entering your home through roof vents. Most roof vents are made of a plastic material with simple window type screening or no screening at all. Animals can and do chew through these vents to enter the attic where they can destroy wiring, cause leaks and do severe damage to your home.



Power Ventilator



Static Vent



Dryer Vent



Tapered Stackable Design

# Animal Exclusion | Roof VentGUARD PLUS™

**New! Control the wild and protect your roof vents by covering them with VentGUARD PLUS.**

**VentGUARD PLUS protects roof vents against wildlife, falling debris, hail, and damage from snow removal.**



STOCK NO	DESCRIPTION	CASE PACK	APPROX. LBS.
VGP01	Gray Painted VentGUARD	1	8
VGP06	Gray Painted VentGUARD	6	47.5

### FEATURES

- Covers Standard Roof Vents
- Retains Venting Area of 50 sq. in.
- Simple Cover and Screw Application
- Ideal for all Roof Pitches
- Built-in Drainage Design
- 100% Recyclable
- Powder Coated Galvanized Steel
- Covers Faded and Damaged Vents
- U.S. and Canada Patents

### Dimensions:

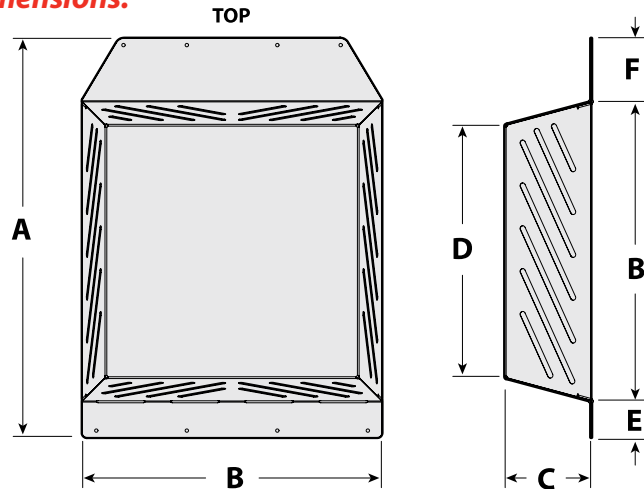

A	B	C	D	E	F
22"	16.5"	4.8"	14"	2"	3.5"

# Animal Exclusion | Foundation VentGuard™

**Keep Rodents, Snakes and Birds from Entering the Home**



### FEATURES

- Design Features a Sturdy 1" Frame with Hemmed Edges for Extra Strength
- 18 Gauge 3/8" Expanded Metal Mesh will Exclude Most Animals and Pests
- One-piece Frame Measures 10" x 18" and is in Stainless Steel or Galvanized Steel
- Screens Provide a Clean, Professional Looking Exclusion Option and also Save Precious Installation Time
- Available in Durable White, Black or Gray Powder Coat Finishes

STOCK NUMBER	BASE SIZE (IN INCHES)	CASE PACK	APPROX. LBS.
VG1018G-10B	10 x 18	10	10.5
VG1018G-10G	10 x 18	10	10.5
VG1018G-10W	10 x 18	10	10.5
VG1018S-10B	10 x 18	10	10.5
VG1018S-10G	10 x 18	10	10.5
VG1018S-10W	10 x 18	10	10.5

# Animal Exclusion | Soffit VentGuard™

**Keep Birds and Squirrels from Entering the Home**



### FEATURES

- Design Features a Sturdy 1" Frame with Hemmed Edges for Extra Strength
- 18 Gauge 3/8" Expanded Metal Mesh Will Exclude Most Animals and Pests
- One-piece Frame Measures 4" x 16" and is Available in Stainless Steel or Galvanized Steel, 4" x 50" is Available in Galvanized Steel
- Screens Provide a Clean, Professional Looking Exclusion Option and also Save Precious Installation Time
- Available in Durable White, Black or Gray Powder Coat Finishes, except for 4 x 50 Size

STOCK NUMBER	BASE SIZE (IN INCHES)	CASE PACK	APPROX. LBS.
VG0416G-10B	4 x 16	10	6
VG0416G-10G	4 x 16	10	6
VG0416G-10W	4 x 16	10	6
VG0416S-10B	4 x 16	10	6
VG0416S-10G	4 x 16	10	6
VG0416S-10W	4 x 16	10	6
VG0450G-10W	4 x 50	10	16



50" Size Available in White Powder Coat Only

# Log Racks | Crescent

STOCK NO	DESCRIPTION	SIZE (L X D X H)	APPROX. LBS.
SCRM	Medium Crescent Log Rack	48 x 14 x 40	30
SCRM-T	Table Top for Medium Crescent	50 x 14 x 1	11
SCRXL	Extra Large Crescent Log Rack	96 x 13 x 45	86



SCRM with SCRM-T



1.25" Square Tube; Holds 1/5 Cord of Wood

SCRM with SCRM-T



SCRXL  
1.5" Square Tube; Holds 1/3 Cord of Wood

### FEATURES

- Heavy-duty Tubular Steel Construction Protects and Neatly Stores Your Firewood
- 14 Gauge Steel (SCRXL) and 16 Gauge Steel (SCRM and SCRM-T)
- Protects Firewood from Rot, Termites, and Nesting Wildlife
- Black Powder Coat Finish Resists Chipping and Corrosion
- Easy to Assemble/Disassemble in Minutes

Made in the U.S.A.

# Log Racks | Adjustable

## Black Painted Steel

STOCK NO	DESCRIPTION	SIZE (L x D x H)	APPROX. LBS.
SLRA	Black-Painted Tubular Steel Log Rack Kit	Adj. x 13" x 42"	15
SLRK	Black-Painted Steel Log Rack Basket Kit - Screws Included	Adj. x 14" x Adj.	6

STORES YOUR FIREWOOD NEATLY AND SAFELY ABOVE THE GROUND



SLRA



SLRK

### FEATURES

- Add 2 x 4's of Any Length to Customize the Storage You Need
- Heavy-Duty Construction
- Black Powder Coat Finish
- Helps Protect Your Firewood from Rot, Termites and Insects
- Easy to Assemble/Disassemble in Minutes
- Made in the U.S.A.

# Log Racks | Deluxe

## Black-Painted Tubular Steel

STOCK NO	DESCRIPTION	SIZE (L x D x H)	APPROX. LBS.
SLRS	Small Tubular Rack - Ideal for Hearthside, Garage or Patio use	28" x 12" x 33"	13
SLRM	Medium Tubular Rack - Convenient Size Suitable for Patio or Garage	45" x 13" x 45"	18
SLRL	Large Tubular Rack - Great for Moderate to Serious Wood Burners	87" x 13" x 45"	23
SLRXL	Extra Large Tubular Rack - Extra Large Capacity, Full 8' Length	99" x 13" x 45"	24

STORES YOUR FIREWOOD NEATLY AND SAFELY ABOVE THE GROUND

### FEATURES

- Open-Air Design Provides Ventilation for Seasoning Firewood and for Cleaner, Safer Burning
- Heavy-Duty Steel Construction
- Protects Firewood from Rot, Termites, and Nesting Wildlife
- Black Powder Coat Finish Resists Chipping and Corrosion
- Easy to Assemble/Disassemble in Minutes



SLRM

SLRXL

Made in the U.S.A.

## Log Racks | Extender Log Rack

### FEATURES

- Heavy-duty 16 Gauge, 1 1/4" Square Tube Construction, Holds Up to 3,000 lbs.
- Holds 1/5 Cord Wood
- Protects Firewood from Rot, Termites, and Nesting Wildlife
- Black Powder Coat Finish Resists Chipping and Corrosion
- Easy to Assemble/Disassemble in Minutes
- Add Extender Kit (SERM-EXT) to Base Unit (SERM) to Extend Log Rack up to 8 Ft, 12 Ft, or 16 Ft

STOCK NO	SIZE (WxHxD)	APPROX LBS
SERM	48" x 45" x 13"	15
SERM-EXT	48" x 45" x 13"	12



## Log Rack Covers | Deluxe

STOCK NO	DESCRIPTION	SIZE (L x D x H)	APPROX. LBS.
SLRCD-S10	Full Cover - Fits (SLRS) Log Rack - 10 Pack	31" x 21" x 26"	25
SLRCD-M10	Full Cover - Fits (SLRM) Log Rack - 10 Pack	48" x 21" x 38"	46
SLRCD-L5	Full Cover - Fits (SLRL) Log Rack - 5 Pack	90" x 21" x 38"	35
SLRCD-XL5	Full Cover - Fits (SLRXL) Log Rack - 5 Pack	100" x 21" x 38"	38

\* Also available individually

### FEATURES

- Durable Woven Polyester Cloth Resists Fading and Cracking
- Protects Your Firewood from the Weather
- Keeps Wood Dry for Easier, Safer Burning
- Includes Metal Grommets to Easily Secure Cover
- Rust Resistant Zippers Allow for Easy Access



## Log Racks | Log Caddy

STOCK NO	DESCRIPTION	SIZE (W x D x H) (IN INCHES)	APPROX. LBS.
SLCAD	Log Caddy - Wood Hauler	24 x 13.5 x 42	15
SLCAD-C	Log Caddy Cover	25" x 21" x 38"	2

### FEATURES

- Heavy Duty All-Steel Frame
- Durable Powder Coat Finish Resists Chipping, Rust, and Corrosion
- Pneumatic Tires Can Handle Stairs and the Toughest Terrain
- Slim Design is Built to Go Through Door Frames and Deck Entries
- Easy-Tilt Axis Operates with Minimal Effort



## Fireplace | Flame Genie™ Wood Pellet Fire Pit

STOCK NO	DESCRIPTION	SIZE (H x D) (IN INCHES)	APPROX. LBS.
FG-16	Wood Pellet Fire Pit	12.5 x 13.5	13.5
FG-T	Wood Pellet Fire Pit Tote	21 x 26	1

### FEATURES

- Patented Design Produces Unique Flame Pattern
- Secondary Combustion Minimizes Smoke
- Burns Easy-to-Handle Wood Pellets, Simple to Clean and Transport
- Constructed of Heavy Gauge Steel
- Minimal Assembly required
- Made in the U.S.A.



Made in the U.S.A.

## Fireplace | Accessories

STOCK NO	DESCRIPTION	SIZE (WxDxH)	APPROX. LBS.
SLT	Canvas Log Tote	29" x 11" x 12"	2

### FEATURES

- Durable, All Black Canvas Carrier with Enclosed Ends
- Reinforced Fabric Handles Wrap Under the Carrier for Complete Support
- Easily Loads/Unloads and Neatly Transports Firewood



STOCK NO	DESCRIPTION	CASE PACK	APPROX. LBS.
ESF-1004-1	Creosote Control Brick - 4 Treatment Pack	1	4
ESF-1004-8	Creosote Control Brick - 8 x 4 Treatment Pack	8	32

### FEATURES

- Helps Prevent Creosote Build-up
- Reduces Risk of Chimney Fires
- Contains no Waxes or Oils
- Made in the U.S.A.
- Made from Douglas Fir and Western Red Cedar
- Burns like Cordwood
- Safe for Use in All Wood Burning Appliances
- Complies with California Proposition 65



## Fireplace | SmokeGuard™

STOCK NUMBER	COLOR	HEIGHT (IN INCHES)	ADJUSTABLE WIDTH (IN INCHES)	APPROX. LBS.
FSG-BLK	BLACK	4	Fits 28 ½ to 48 Wide	5
FSG-BLK-6	BLACK	6	Fits 28 ½ to 48 Wide	6
FSG-BLK-8	BLACK	8	Fits 28 ½ to 48 Wide	7
FSG-BRS	BRASS	4	Fits 28 ½ to 48 Wide	5

Most fireplaces smoke because the opening is too high. SmokeGuard reduces the fireplace opening. It improves the draft and easily corrects the problem!

### FEATURES

- Fixes Flue-to-Firebox Ratio Problems
- Black Powder Coat Finish
- Also Available in Plated Brass
- Spring Loaded for Easy Installation
- Heat Resistant Adhesive Caulk (included) Seals SmokeGuard in Position



Before



After

Made in the U.S.A.

## Fireplace | Fire Backs

STOCK NUMBER	SIZE (IN INCHES)	APPROX. LBS.
FB1515	15 x 15	5
FB1618	16 x 18	6.5
FB2020	20 x 20	9
FB2424	24 x 24	12.5
FB2727	27 x 27	16



- Advantages of Stainless Steel Construction vs. Cast Iron:
  1. Lighter Weight = Easier Placement
  2. Less Expensive
- Slotted Base Allows for Adjustable Installation (65 - 90 degrees)
- Made in the U.S.A.

## Liberty Foundry | Clean Out Door

STOCK NUMBER	SIZE (IN INCHES)	APPROX. LBS.
COD88	8 x 8	8

### FEATURES

- Replaces Rusted or Broken Clean Out Doors, for Easy Access to Your Chimney
- Hinged with a Single-Bolt Closure
- Works for Indoor or Outdoor Clean Outs



## Fireplace | Accessories



STOCK NO	DESCRIPTION	CASE PACK	APPROX. LBS.
SE-1	Soot Eraser Single Pack	1	0.4
SE-24	Soot Eraser Bulk Pack	24	9

### Use Completely Dry!

- No Scrubbing • No Mess
- No Solvents • No Cleanser
- 100% Natural Vulcanized Rubber
- Non-Toxic

The "Soot Eraser" works like an eraser, absorbing smoke residue, soot, fly-ash and dirt. Works on most surfaces including:

- Brick
- Mantels
- Fireplace Hearth
- Woodwork
- Window Blinds
- Window Shades
- Most Wallpaper
- Painted Walls



These Kettle Steamers provide beauty and add humidity to any room. Available in 2.5 & 5 quart size (K25 & K50). These Kettle Steamers may not be used for drinking water.

STOCK NUMBER	SIZE	APPROX. LBS.
K25-BLK-P	2.5 QUARTS	11
K50-BLK-P	5.0 QUARTS	16

Fireplace | Stepflame™ Custom Fire Grate

STOCK NUMBER	WIDTH - FRONT (IN INCHES)	WIDTH - BACK (IN INCHES)	DEPTH (IN INCHES)	APPROX. LBS.
CFG27	26	19	16¼	41
CFG30	29¼	22	16¼	43
CFG32	31¼	24	16¼	45



The innovative Stepflame™ Custom Fire Grate is the first ever dual-tiered design for a fire grate. It dramatically enhances the fire presentation - more volume and better airflow. Boosts energy efficiency, allowing for a complete burn.

FEATURES

- Easy to Assemble, No Tools Needed
- Removeable Tray, Makes for Easy Clean-up
- Laser Cut Steel
- Black Powder Coat Finish
- Made in the USA

Fireplace | Steel Bar Grate

STOCK NO	DESCRIPTION	WIDTH (IN INCHES)		DEPTH (IN INCHES)	LEG HEIGHT (IN INCHES)	APPROX. LBS.
		FRONT	BACK			
G200-18	Steel Bar Grate - 4 bars	18	12	12	5	10
G200-24	Steel Bar Grate - 5 bars	24	21	15	5	15
G200-27	Steel Bar Grate - 6 bars	27	24	15	5	16
G200-30	Steel Bar Grate - 7 bars	30	27	15	5	20

FEATURES

- Heavy-duty 5/8" Solid Steel Bar Construction
- Black Finish
- Holds Firewood off the Fireplace Floor Allowing Air to Circulate
- Designed to Safely Contain Firewood
- Ember Retainer Helps Keep Fire Hotter and Burn More Efficiently
- No Assembly Required



GT SAF-T-GRATE® SERIES

Heavy duty self-feeding expandable fireplace grate. Saf-T-Grates are shipped knocked-down in a carton for easy storage.

STOCK NUMBER	APPROX. LBS.	WIDTH (IN INCHES)		DEPTH (IN INCHES)
		FRONT	BACK	
GT-18	22	18	14	12
GT-22	32	22½	18	16
GT-30	40	30	26	16



GT-22

G500 SAMPSON SERIES

Heavy duty self-feeding expandable fireplace grate. Use the 8" G500-C to expand the width of any of the G500 grates. G500 grates are shipped knocked-down in a carton for easy storage. Patent #235412

STOCK NUMBER	APPROX. LBS.	WIDTH (IN INCHES)		DEPTH (IN INCHES)
		FRONT	BACK	
G500-20	22	20	16	16
G500-24	27	24	20	16
G500-28	33	28	24	16
G500-32	37	32	28	16
G500-36	41	36	32	16
G500-C	8	8	8	16



G500-24

G500-C Center Section

G SERIES FRANKLIN

One piece cast flat bottom style fireplace grate with 12" depth for use in small fireplaces and Franklin Stoves. Available with 2" or 4" cast-on legs.

STOCK NUMBER	APPROX. LBS.	HEIGHT (IN INCHES)	WIDTH (IN INCHES)		DEPTH (IN INCHES)
			FRONT	BACK	
G16	12	5	15¼	15¼	9
G17	15	5	17	12½	12
G22	20	5¼	22	18½	12
G27	22.5	5¼	27	22	12



G22

Also available with 4" leg cast on.

G800 SERIES

One piece cast flat bottom style fireplace grate with cast on 4" legs.

STOCK NUMBER	APPROX. LBS.	HEIGHT (IN INCHES)	WIDTH (IN INCHES)		DEPTH (IN INCHES)
			FRONT	BACK	
G800-20	20	7	19½	16	15
G800-24	23.5	7	24	20¼	15
G800-27	26	7	27	23¼	15



G800-24  
4" leg cast on

G1000 SERIES

One piece cast curved basket style fireplace grate with 2.5" removable legs.

STOCK NUMBER	APPROX. LBS.	WIDTH (IN INCHES)		DEPTH (IN INCHES)
		FRONT	BACK	
G1024	30	24¼	20	15½
G1028	34	28½	23½	15½



G1024

Also available with 4" removable legs.

All grate measurements are approximate and may vary slightly from lot to lot.

## Stove Boards | Non-UL Lined



### FEATURES

- Provides Ember and Scratch Protection Only; Non-UL Provides No Thermal Protection
- Use Non-UL Stove Boards Under other Heating Appliances Such as Kerosene, Gas and Electric Heaters
- Non-UL Stove Boards May Not Be Used as Wall Shields
- Not to be Used Outdoors

STOCK NUMBER	DESCRIPTION	CASE PACK	APPROX. LBS.
L2832BL-3	28 x 32 Lined - Black	3	22
L2832GT-3	28 x 32 Lined - Gray Slate Tile		
L2832ST-3	28 x 32 Lined - Sandstone Tile		
L2832WW-3	28 x 32 Lined - Woodgrain		
L3242BL-3	32 x 42 Lined - Black	3	31
L3242GT-3	32 x 42 Lined - Gray Slate Tile		
L3242ST-3	32 x 42 Lined - Sandstone Tile		
L3242WW-3	32 x 42 Lined - Woodgrain		
L3636BL-3	36 x 36 Lined - Black	3	32
L3636GT-3	36 x 36 Lined - Gray Slate Tile		
L3636ST-3	36 x 36 Lined - Sandstone Tile		
L3636WW-3	36 x 36 Lined - Woodgrain		
L3648BL-3	36 x 48 Lined - Black	3	42
L3648GT-3	36 x 48 Lined - Gray Slate Tile		
L3648ST-3	36 x 48 Lined - Sandstone Tile		
L3648WW-3	36 x 48 Lined - Woodgrain		
L3652BL-3	36 x 52 Lined - Black	3	45
L3652GT-3	36 x 52 Lined - Gray Slate Tile		
L3652ST-3	36 x 52 Lined - Sandstone Tile		
L3652WW-3	36 x 52 Lined - Woodgrain		

## Accessories | Installation Kits

STOCK NUMBER	DESCRIPTION	APPROX. WEIGHT LBS.
ULSK	Wall Spacer Kit	.5
ULEG	UL Electrical Grounding Kit	.5
ULCK	Connector Kit	.5



ULSK

## Stove Boards | Type 2 - Tested to UL1618



### FEATURES

- Protect Your Floors From the Intense Heat, Hot Coals, Ashes and Soot that Wood Stoves Can Produce
- Use a Stove Board/Hearth Extender to Protect the Floor in Front of your Fireplace
- Embossed Printed Steel and 1/2" Specially Formulated Fiber Board Backing Material - Non-Combustible Thermal Protection
- Stove Boards Tested to UL1618 May be Used as Wall Shields to Protect Your Walls from Heat
- R-Value = 1.56

STOCK NUMBER	DESCRIPTION	CASE PACK	APPROX. LBS.
T2UL1848BL-1	18 x 48 Type 2 UL-Compliant - Black	1	11
T2UL1848GT-1	18 x 48 Type 2 UL-Compliant - Gray Slate Tile		
T2UL2832BL-1	28 x 32 Type 2 UL-Compliant - Black	1	11
T2UL2832GT-1	28 x 32 Type 2 UL-Compliant - Gray Slate Tile		
T2UL2832ST-1	28 x 32 Type 2 UL-Compliant - Sandstone Tile		
T2UL2832WW-1	28 x 32 Type 2 UL-Compliant - Woodgrain		
T2UL3242BL-1	32 x 42 Type 2 UL-Compliant - Black	1	18
T2UL3242GT-1	32 x 42 Type 2 UL-Compliant - Gray Slate Tile		
T2UL3242ST-1	32 x 42 Type 2 UL-Compliant - Sandstone Tile		
T2UL3242WW-1	32 x 42 Type 2 UL-Compliant - Woodgrain		
T2UL3636BL-1	36 x 36 Type 2 UL-Compliant - Black	1	18
T2UL3636GT-1	36 x 36 Type 2 UL-Compliant - Gray Slate Tile		
T2UL3636ST-1	36 x 36 Type 2 UL-Compliant - Sandstone Tile		
T2UL3636WW-1	36 x 36 Type 2 UL-Compliant - Woodgrain		
T2UL3648BL-1	36 x 48 Type 2 UL-Compliant - Black	1	23
T2UL3648GT-1	36 x 48 Type 2 UL-Compliant - Gray Slate Tile		
T2UL3648ST-1	36 x 48 Type 2 UL-Compliant - Sandstone Tile		
T2UL3648WW-1	36 x 48 Type 2 UL-Compliant - Woodgrain		
T2UL3652BL-1	36 x 52 Type 2 UL-Compliant - Black	1	25
T2UL3652GT-1	36 x 52 Type 2 UL-Compliant - Gray Slate Tile		
T2UL3652ST-1	36 x 52 Type 2 UL-Compliant - Sandstone Tile		
T2UL3652WW-1	36 x 52 Type 2 UL-Compliant - Woodgrain		
T2UL4048BL-1	40 x 48 Type 2 UL-Compliant - Black	1	28
T2UL4848BL-1	48 x 48 Type 2 UL-Compliant - Black	1	31



**New! Gardus Rotary Cleaning Systems Attach to a Cordless Drill to Effectively Clean Hard to Reach Areas**

The LintEater® is the most valuable tool one can own for ensuring safe operation of your clothes dryer. Easy to use with a cordless drill. Provides a means for thorough cleaning of the entire dryer vent system.



1 - Self-feeding 4" Auger Brush



4 - 36" Long Flexible rods



1 - Blockage Removal Tool



1 - Large 2.5" dia. Lint Brush

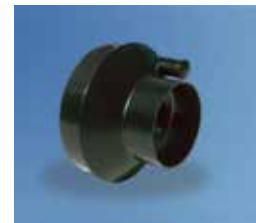

1 - Vacuum Adapter

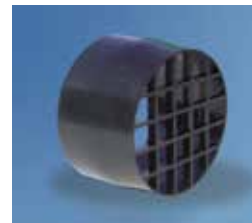

1 - Dryer Adapter

STOCK NO	DESCRIPTION	SIZE (H x D) (IN INCHES)	APPROX. LBS.
RLE202	LintEater - Rotary Dryer Vent Cleaning System	27 x 3.4	2.5
RJR601	4 pc. LintEater Dryer Vent Kit Jr., 3ft	20.5 x 6	.5
R4203613	LintCatcher - Lint Collection Bag	9 x 6	.5
R3203612	12' Extension Kit for LintEater	38 x 2	.25
LGM7	LintGard - Dryer Safety Monitor	6.5 x 6.5	.5



LintCatcher for catching lint while cleaning.



LintEater Jr. for shorter vents. Includes two 18" rods.



LintGard for monitoring lint build up in dryer vents. Helps save on electricity and prevent dryer fires.



**FEATURES**

- Helps Prevent Flue Fires!
- Unique "Trim-to-Fit" Design Cleans Multiple Flue Sizes and Shapes (Round-Square-Rectangle-Oval)
- Works with Any Cordless Drill
- Won't Scratch Metal Flues Like Steel Brushes
- Fits through Tight Areas
- Replaceable Whip Line
- Spins "Forward" and "Reverse"



The 'Spinning Whip' Advantage!



6- 3' long flexible rods with reversible "button link" quick connect system

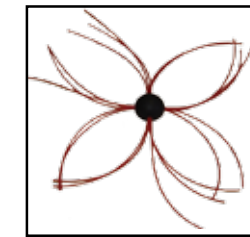

1 - Trim-to-fit spin whip



1- Drill adaptor  
1- Hex key



1 - 52" x 48" fireplace/  
stove opening cover

STOCK NO	DESCRIPTION	SIZE (H x D) (IN INCHES)	APPROX. LBS.
RCH205-B	SootEater - Rotary Chimney Cleaning System	38 x 3	4.5
CRD307	Extension Rods for SootEater Chimney System	37 x 1	1
RCWL209	Replacement Whip Line	8 x 8	.1
CWH208	Replacement Head w/ line for SootEater	20.5 x 8.5	.4
RPS204-B	SootEater - Rotary Pellet Cleaning System	37 x 2.5	1.5
PRD308	Extension Rods for SootEater Pellet System	36 x 1	.5



Rotary Pellet Cleaning System for Pellet Stove Pipes, includes:

- 3 - 3' Rods
- 1- 4" 'Propeller' Brush
- 1 - 3" 'Propeller' Brush
- 1 - Long handled Stove Cleaning Brush with Scraper

# GutterSweep

New! Gardus Rotary Cleaning Systems offer an easy way to clean clogged gutters without stepping on a ladder.

STOCK NO	DESCRIPTION	SIZE (H x D) (IN INCHES)	APPROX. LBS.
GS900	GutterSweep - Gutter Clean Rotary System	27 x 3.4	2.5
GXX906	Gutter Clean Rotary System Extension Kit, 2-3 FT	38 x 2	.5



**FEATURES**

- Power the GutterSweep rotary paddle with your power drill.
- Flush your gutters by connecting GutterSweep to your garden hose and use the waterjet brush or waterjet scoop.
- Up to 12' reach for single story gutters.
- Camera mount to attach a camera to photograph your gutters.



## Pro-Scan PS-3188 Manual Adjust

- Camera head size: 0.9" dia. x 1.8" L
- Total Pixels PAL 720 x 576 NTSC 720 x 480
- Field of view 120°
- Camera lighting 12 high intensity white LEDs
- 8 inch TFT color monitor; resolution 800 x 600
- DVR Function
- 4400mA Li-ion battery pack power supply
- Charging time 5 hours, working time 6 hours
- 30m soft cable with cable reel
- ABS carry case (size: 12.6" x 9" x 5")
- Power supply DC 12V



## Pro-Scan PT-4188 Pan & Tilt

- Camera size: 2" x 6" [50mm x 153mm]
- Total Pixels PAL 720 x 576 NTSC 720 x 480
- View range +/- 180°, rotation endless (slip ring)
- 6 high intensity LEDs - adjustable
- 8 inch TFT color monitor
- DVR Function
- 4400mA Li-ion battery pack power supply
- Charging time 5 hours, working time 6 hours
- 30m soft cable with cable reel
- ABS carry case (size: 12.6" x 9" x 5")



STOCK NO	DESCRIPTION	SIZE (H x D x W) (IN INCHES)	PRICE
PS-3188	Manual Adjust Video Inspection Camera	12.6 x 9 x 5	\$1499.00
PT-4188	Pan & Tilt Video Inspection Camera	12.6 x 9 x 5	\$3999.00

## Chimney Liner Systems | All Fuel Universal Kits



### FEATURES

- 7-Ply 3/16" Stainless Steel for Superior Strength and Durability
- Rugged 10-Groove Construction Allows for Expansion and Contraction
- Reduces Creosote Build-up in the Chimney
- Limited Lifetime Warranty

## Class A Chimney Systems | Premium Grade Stainless



### FEATURES

- ShelterPro Chimney is Designed to Handle Temperatures up to 2100°F with Superior Durability and Safety
- Inner Liner and Outer Casing are Both Grade 304 Stainless Steel, Designed to Prevent Corrosion and Keep out Moisture
- Premium Fiber Insulation Ensures Minimal Loss of Heat
- Offered in 6" and 8" Diameters and a Variety of Lengths, Includes a Lifetime Warranty

Made in the U.S.A.

## Chimney Systems | Magic Heat™ Heat Reclaimer

STOCK NO	DESCRIPTION	SIZE (H x W x D) (IN INCHES)	APPROX. LBS.
MH-6	6" Top Crimp	18 ¼ x 10 ⅝ x 14 ¼	28
MH-7	7" Top Crimp	18 ¼ x 10 ⅝ x 14 ¼	28
MH-8	8" Top Crimp	18 ¼ x 10 ⅝ x 14 ¼	28
MH-6R	6" Bottom Crimp	18 ¼ x 10 ⅝ x 14 ¼	28
MH-7R	7" Bottom Crimp	18 ¼ x 10 ⅝ x 14 ¼	28
MH-8R	8" Bottom Crimp	18 ¼ x 10 ⅝ x 14 ¼	28
MH-6G	6" Gas/Top Crimp	18 ¼ x 10 ⅝ x 14 ¼	28
MH-7G	7" Gas/Top Crimp	18 ¼ x 10 ⅝ x 14 ¼	28
MH-8G	8" Gas/Top Crimp	18 ¼ x 10 ⅝ x 14 ¼	28



### FEATURES

- Magic Heat Will Reclaim up to 30% of Lost Heat from a Stove and Distribute it into the Home
- Available in 6", 7" or 8" Flue Diameters, Crimp up or Crimp down Configuration
- Designed for use with all Types of Heating Equipment with Inside Flue Temperatures Exceeding 350°F/177°C, Skin Temperatures of 250°F/121°C
- Can use Thermostatic Control or Run Continuously
- Thermostat Control Mode; ON at 150°F/66°C, OFF at 120°F/44°C
- BTU Output Variable: 8000 BTU minimum - 30,000 maximum
- Plugs into any Standard Outlet
- Fan 8" 225 CFM, Motor 120 V/60 Hz
- One year Limited Warranty

## Forced Air Furnaces | Wood and Coal



### FEATURES

- Patented Heat Dump Protects Electrical Controls and Structure in Case of Power Loss
- Prewired Electrical System
- Secondary Combustion Chamber Boosts Efficiency
- 1/3 Horsepower 1800 CFM Blower Motor
- Five Year Limited Warranty on Firebox and Grates

Made in the U.S.A.



### FEATURES

- Many Models Utilize 360° Roller Grates
- Filter Box Comes Standard
- Thermostatically Controlled Draft System
- 1/3 Horsepower 1800 CFM Blower Motor
- Five Year Limited Warranty on Firebox and Lifetime Warranty on Grates

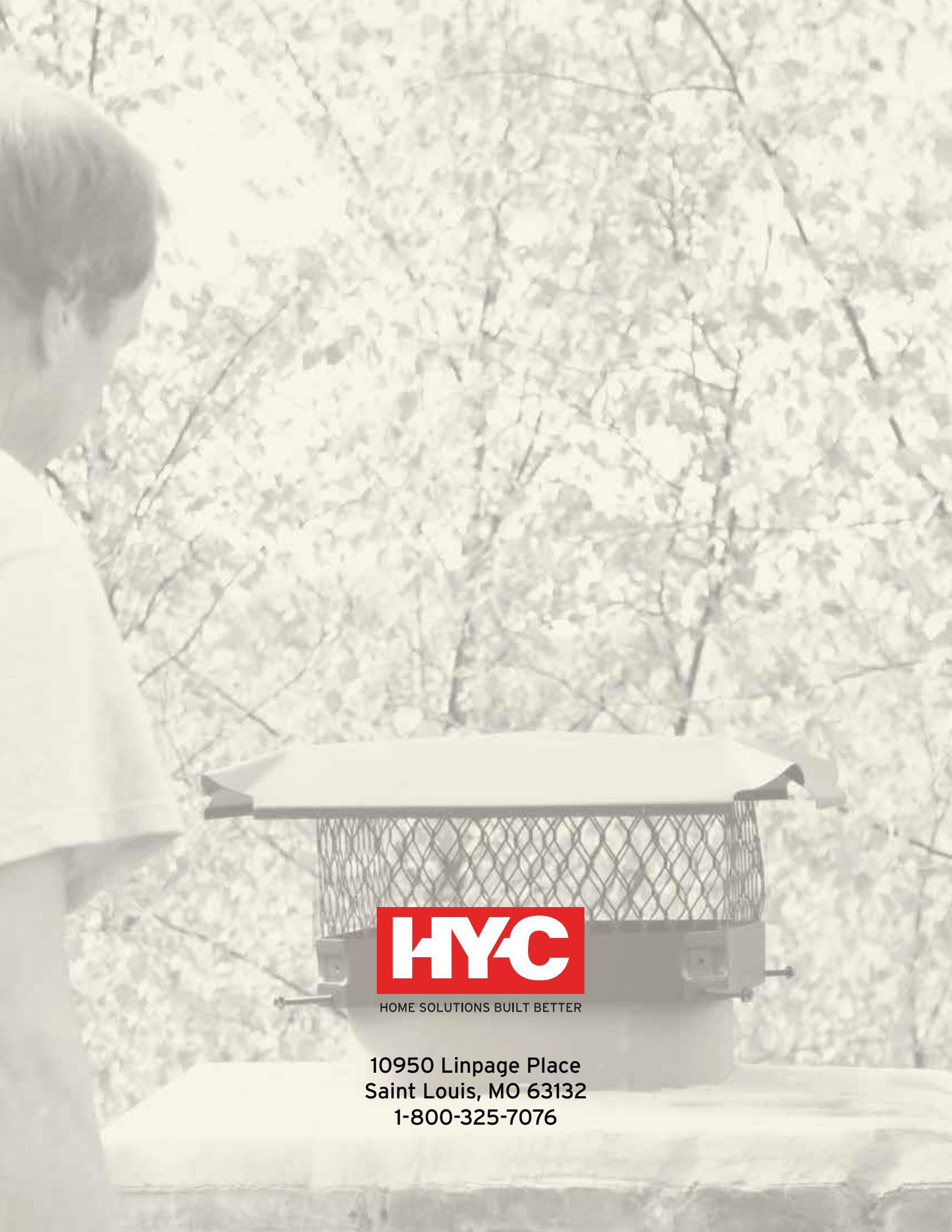

HOME SOLUTIONS BUILT BETTER

10950 Linpage Place  
Saint Louis, MO 63132  
1-800-325-7076